

norma
AUDIO ELECTRONICS

REVO IPA-80

Stereo Integrated Amplifier

Manual

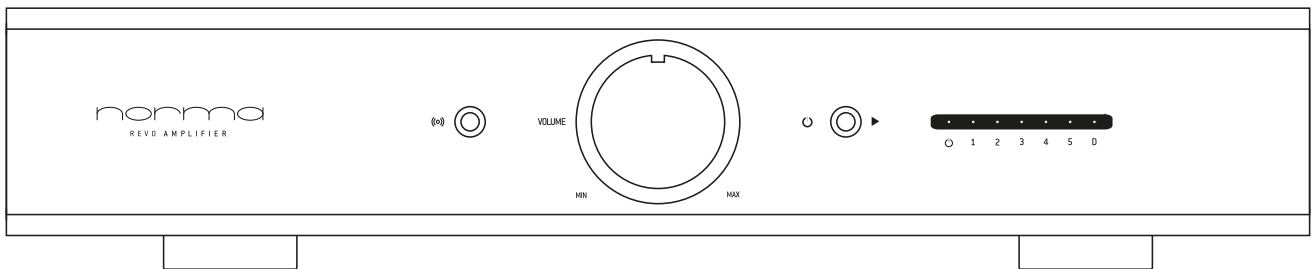

Safety manual

REVO IPA-80

Contact informations

Make sure you register your purchase.

Visit: <http://www.normaudio.com/normaudio/>

Documentation Conventions

This document contains general safety and operation instructions for your Norma product. It is important to read this document before attempting to use this device. Please pay particular attention to safety instructions.

The information that the manual contains is subject to change without notice. NORMA assumes no responsibility for errors that may appear within this document and is restricted for use by NORMA Audio.



Copyright and Acknowledgements

Copyright © 2020 Norma Audio. First edition March 2020.

Opal Electronics - Via Persico, 26 - Loc. Bettenesco

Persico Dosimo (Cremona)

Italy

All rights reserved. No part of this publication may be reproduced, stored in a retrieval system, or transmitted, in any form or by any means, electronic, mechanical, photocopying, recording, or otherwise, without the prior written permission of the publisher.

Printed in Italy.

NORMA has the right to make changes to this document without notice.

I • Introduction

Thank you for purchasing a NORMA Audio product.

Please read this manual thoroughly before making connections and plugging in the unit to the mains power supply.

Following the instructions in this manual will enable you to obtain optimum performance and listening enjoyment from your new NORMA unit.

Please retain this manual for future reference.



CAUTION
RISK OF ELECTRIC SHOCK
DO NOT OPEN



CAUTION:
TO REDUCE THE RISK OF ELECTRIC SHOCK, DO NOT REMOVE COVER (OR BACK). NO USER-SERVICEABLE PARTS INSIDE. REFER SERVICING TO QUALIFIED SERVICE PERSONNEL.

 The lightning flash with arrowhead symbol, within an equilateral triangle, is intended to alert the user to the presence of uninsulated "dangerous voltage" within the products enclosure that may be of sufficient magnitude to constitute a risk of electric shock to persons.

 The exclamation point within an equilateral triangle is intended to alert the user to the presence of important operating and maintenance (servicing) instructions in the literature accompanying the appliance.

WARNING:
TO PREVENT FIRE OR ELECTRIC SHOCK, DO NOT EXPOSE THIS APPLIANCE TO RAIN OR MOISTURE.

II • Unpacking

Follow these steps to safely unpack the NORMA unit:

- Open the shipping box and remove the top layer of foam. Be careful not to damage the inside of the package with the knife.

The packaging must contain the following items:

1 NORMA;

1 Remote control unit;

1 AC power cord (in some countries);

1 User manual;

1 Warranty police and registration card.

- Grab the underside of the NORMA unit and lift it straight out of the packing box;

- Place the NORMA unit in a safe location and remove the protective plastic wrapping.

Note:

If any accessories are missing, or if the unit is damaged or fails to operate, notify your dealer immediately. If the unit was shipped to you directly, notify your shipper immediately. NORMA recommends that you retain the original carton and packing materials in case you need to move or ship the unit in the future. Neither NORMA or the shipper can be held responsible for damages incurred during transit if the original factory packing is not used. All factory returns require that a previous return authorization number be issued by NORMA prior to shipment.

Keep this manual handy for future reference.

Register your NORMA unit online at www.normaudio.com within 15 days of purchase. Retain the original, dated sales receipt as proof of warranty coverage.

▲ **Caution:**
Keep the carton box, the foam protection and the PET sheet out of the reach of children, choking hazard.

REVO IPA-80 / Safety manual

I / II • Introduction / Unpacking ◀ |

III • Before use

⚠ IMPORTANT SAFETY INSTRUCTIONS ⚠

Read this section carefully to ensure safe operation

▶ **III.I General**

III.I.I • Read these instructions

All the safety and operating instructions should be read before the product is operated.

III.I.II • Keep these instructions

The safety and operating instructions should be retained for future reference.

III.I.III • Heed all warnings

All warnings on the product and in the operating instructions should be adhered to.

III.I.IV • Follow all instructions

All operating and use instructions should be followed.

III.I.V • Preventing hearing loss

Caution, excessive sound pressure from earphones and headphones can cause hearing loss.

III.I.VI • The labels containing information about safety must be always visible and in good conditions

▶ **III.II Positioning**

III.II.I • Environment and space requirements

Operating environment temperature and humidity: +5 °C to +35 °C (+41 °F to +95 °F); less than 80% RH (cooling vents not blocked). Do not install this unit in a poorly ventilated area, or in locations exposed to excessive humidity or direct sunlight (or strong artificial light).



Due to stray magnetic fields, turntables, amplifiers and CD players should not be located nearby due to possible interference.



Do not use this product in an explosive atmosphere.



Keep electrical device out of the reach of children. Injuries and shock hazard.



Avoid locations subject to vibration and excessive dust. The dust could accumulate and cause overheating.



III.II.II • Stands

The important weight of our products require that they are placed only on an adequate mechanical structure. We are not responsible for injuries or damages due to a wrong positioning. Do not put NORMA devices on high places, to avoid injury from tip-over or falling. This product cannot be mounted to a wall or ceiling.



III.II.III • Object and Liquid Entry

Do not use this apparatus near water

This product shall not be exposed to dripping and splashing, for example near a bath tub, wash bowl, kitchen sink, laundry tub, in a wet basement, near a swimming pool and the like. Do not place an object containing liquid, such as a flower vase, on the appliance even if it is switched off.

Never spill liquid of any kind on the product.

Internal condense can be formed if the amplifier is carried from an extremely cold environment to an extremely hot one. Please wait at least for an hour before operating it again. Never push objects of any kind into the apparatus through openings as they may touch dangerous voltage points or short-out parts that could result in a fire or electric shock.

Never use this product with wet hands, shock and injury hazard.



III.II.IV • Flame

Do not place a flaming object, such as a candle or lantern, or near the product. Do not use free flames or flammable substances near this appliance.



III.II.V • Ventilation

Slots and openings in the cabinet are provided for ventilation and to ensure reliable operation of the product and to protect it from overheating. Do not block any ventilation openings. Install in accordance with the manufacturers instructions. Ventilation should not be impeded by covering the ventilation openings with items such as newspapers, table cloths, curtains and so on. The openings should never be blocked by placing the product on a bed, sofa, rug, or other similar surface. This product should not be placed in a built-in installation such as a bookcase or rack unless proper ventilation is provided or the manufacturers instructions have been adhered to. Ensure that there is adequate ventilation. Leave 20 cm (8") of free space at the top and sides and 10 cm (4") at the rear. The rear edge of the shelf or board above the apparatus shall be set 10 cm (4") away from the rear panel or wall, creating a flue-like gap for warm air to escape.



III.II.VI • Heat

Do not install near any heat sources such as radiators, heat registers stoves, or other apparatus (including amplifiers) that produce heat.



III.II.VII • Batteries

The remote control batteries cannot be exposed to excessive heat such as sunshine, any improper use may result in fire or personal injuries.

▶ III.III Power

III.III.I • AC fuse

The AC fuse inside the unit is not user-serviceable. If you cannot turn on the unit, contact your NORMA dealer.

III.III.II • Power sources

This product should be operated only from the type of power source indicated on the product. If you are not sure of the type of power supply to your home, consult your product dealer or local power company.

▲ AC outlet voltages vary from country to country. Make sure that the voltage in your area meets the voltage requirements printed on the unit's rear panel (e.g. AC 230 V, 50 Hz or AC 120 V, 60 Hz). The power cord plug is used to disconnect this unit from the AC power source. Make sure that the plug is readily operable (easily accessible) at all times.

The unit is of class 1 construction and must be connected to a mains socket outlet with a protective earthing connection.

III.III.III • Mains cord

The mains cord is intended to be safely disconnected to the device for this apparatus and shall remain readily operable at all times.

Be sure to insert each power cord securely. To prevent hum and noise, do not bundle the interconnect leads with the power cord or speaker leads.

To completely disconnect this product from the mains, disconnect the plug from the wall socket outlet. The mains plug is used to completely interrupt the power supply to the unit and must be within easy access by the user.

III.III.IV • Power plug / Wall outlet

- If the AC plug of this unit does not match the AC outlet you want to use, the plug must be removed and appropriate one fitted.

- Replacement and mounting of an AC plug on the power supply cord of this unit should be performed only by qualified service personnel.



Contact your NORMA dealer for more information.

- If connected to an AC outlet, the cut-off plug can cause severe electrical shock. Make sure it is properly disposed of after removal.

▲ To avoid fire hazard or other problems, the equipment should be disconnected by removing the mains plug from the wall socket when left unused for a long period of time (for example, when on vacation).

- This product must be terminated with a three-conductor AC mains power cord that includes an earth ground connection. To prevent shock hazard, all three connections must ALWAYS be used.

III.III.IV.I • UK plug-fitting instructions (UK only)

This appliance is supplied with a moulded three pin mains plug for your safety and convenience. A 13 amp fuse is fitted in this plug. Should the fuse need to be replaced, please ensure that the replacement fuse has a rating of 13 amps and that it is approved by ASTA or BSI to BS1362. Check for the ASTA mark  or the BSI mark  on the body of the fuse.

If the plug contains a removable fuse cover, you must ensure that it is refitted when the fuse is replaced. If you lose the fuse cover the plug must not be used until a replacement cover is obtained. A replacement fuse cover can be obtained from your local dealer. If the fitted moulded plug is unsuitable for your socket outlet, in any case cut the cord for replace the plug. There is a danger of severe electrical shock if the cut off plug is inserted into any socket. Please contact your local dealer for the appropriate power cord with appropriate plug.

Q How to replace the fuse

Open the fuse compartment with a screwdriver and replace the fuse.

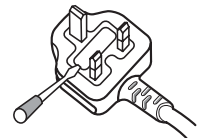

III.III.V • Mains switch

When the switch is in the OFF position, the equipment is not completely switched off from mains.

▲ The STANDBY mode on this unit will not completely shut off all power from the AC outlet. Since the power cord serves as the main disconnect device for the unit, you will need to unplug it from the AC outlet to shut down all power. Therefore, make sure the unit has been installed so that the power cord can be easily unplugged from the AC outlet in case of an accident.

III.III.VI • Power supply

If an external power supply is required, the equipment shall be installed near the power supply so that the power supply is easily accessible.

III.III.VII • Power cord protection

Protect the power cord from being walked on or pinched particularly at plugs, convenience receptacles, and the point where they exit from the apparatus. Do not handle the mains cord with wet hands.

III.III.VIII • Overload protection and prevention

Do not overload wall outlets, extension cords, or integra convenience receptacles as this can result in a risk of fire or electric shock.

Be sure that the used wall outlet and the circuitry above it can provide the correct amount of current without significant voltage drop. It can result in a risk of fire or electric shock.

III.III.IX • Lightning protection

Always unplug this apparatus during lightning storms.
For additional security, remove all connections from the unit when unused for long periods of time.

▶ III.IV Servicing

III.IV.I • Do not try to repair this product

Do not attempt to service this product yourself as opening or removing covers may expose you to dangerous voltage or other hazards. Refer all servicing to qualified service personnel.

For technical assistance, please contact a qualified technician or a NORMA dealer.

III.IV.II • Damage requiring service

- Refer all servicing to qualified service personnel.

- Servicing is required when the apparatus has been damaged in any way, such as power-supply cord or plug is damaged, liquid has been spilled or objects have fallen into the apparatus, the apparatus has been exposed to rain or moisture, does not operate normally, or has been dropped.

III.IV.III • Service warning

Unplug the apparatus from the wall outlet and refer servicing to qualified service personnel under the following conditions:

- When the power-supply cord or plug is damaged;
- If liquid has been spilled, or objects have fallen into the apparatus;
- If the apparatus has been exposed to rain or water;
- If the apparatus does not operate normally by following the operating instructions. Adjust only those controls that are covered by the operating instructions as an improper adjustment of other controls may result in damage and will often require extensive work by a qualified technician to restore the apparatus to its normal operation;
- If the apparatus has been dropped or damaged in any way;
- When the apparatus exhibits a distinct change in performance this indicates a need for service.

III.IV.IV • Replacement parts and accessories

When replacement parts are required, be sure the service technician has used replacement parts specified by the manufacturer or have the same characteristics as the original part. Unauthorized substitutions may result in fire, electric shock, or other hazards.

Use only accessories and optional boards specified by the manufacturer. Clone or non-original accessories may result in fire, electric shock or other hazards.

III.IV.V • Safety check

Upon completion of any service or repairs to this product, ask the service technician to perform safety checks to determine that the product is in proper operating condition.

III.IV.VI • Never disassemble or modify the unit

Do not use this product with any covers removed, shock hazard. Do not bypass any fuse, it may cause damages and fire.

▶ III.V Care & maintenance

III.V.I • Cleaning

| |
|---|
| ▲ Unplug this product from the wall outlet before cleaning. |
|---|

- Do not use liquid cleaners or aerosol cleaners;
- Use a damp cloth for cleaning;
- Do not let insecticides, benzene, and thinner come in contact with the unit, absolutely do not use these substances to clean the unit.

IV • Operating

▶ IV.I Connections

▲ Warning:

When making connections to this or any other component, make sure all components are off. Turn off all systems power before connecting the NORMA unit to any other component. For additional security, remove the power cord before making the connections.

Make sure all cable terminations are of the highest quality, free from frayed ends, short circuits, or cold solder joints.

- Before making any connections, make sure all power is turned off and only use suitable interconnects. For additional security, remove the power cord before making the connections;
- Before attempting any system interconnection, please familiarize yourself with the front and rear panel controls of the NORMA unit;
- Do not connect the NORMA unit speakers output terminals to any device other than a loudspeaker. Do not short-circuit the amplifier's output terminals. Never connect the output terminals of one amplifier to the output terminals of another amplifier.

▶ IV.II Warming up

This unit's top, bottom and lateral heatsinks may get hot after prolonged use. This is normal but avoid touching them.

▶ IV.III Running in time

Electronic audio components have a running in time of around a 200 - 300 hours. This will allow the new components to settle down and the sonic properties will improve over this time.

▶ IV.IV Long time do not use

If you do not use this unit for a long time, it may not work properly the next time you turn it on, so be sure to use it occasionally.

If you intend not to use the remote controller for a long time, remove the batteries to prevent damage from leakage or corrosion. Remove expired batteries as soon as possible to prevent damage from leakage or corrosion. Do not leave rubber or plastic items on this unit for a long time, because they may leave marks on the case.

▶ IV.V Application fields

This product is for general household purposes. Any failure due to use for other than household purposes (such as long-term use for business purposes in a restaurant or use in a car or ship) and which requires repair will be charged for even during the warranty period.

V • Recycling & waste

🔍 V.I Notes about recycling



This products packaging materials are recyclable and can be reused. Please dispose of any materials in accordance with the local recycling regulations. When discarding the unit, comply with local rules or regulations.

Batteries should never be thrown away or incinerated but disposed of in accordance with the local regulations concerning battery disposal. This product and the supplied accessories, excluding the batteries, constitute the applicable product according to the WEEE directive. Products and batteries with the symbol (crossed-out wheeled bin) cannot be disposed as household waste. Old electrical and electronic equipment and batteries should be recycled at a facility capable of handling these items and their waste byproducts. Contact your local authority for details in locating a recycle facility nearest to you.

▶ V.II Information on disposal for users (private households)

V.II.I • In the European Union

▲ Attention:

If you want to dispose of this equipment, please do not use the ordinary dust bin. Used electrical and electronic equipment must be treated separately and in accordance with legislation that requires proper treatment, recovery and recycling of used electrical and electronic equipment.

Following the implementation by member states, private households within the EU states may return their used electrical and electronic equipment to designated collection facilities free of charge. In some countries your local retailer may also take back your old product free of charge if you purchase a similar new one.

If your used electrical or electronic equipment has batteries or accumulator, please dispose of these separately before and according to local requirements.

By disposing of this product correctly you will help ensure that the waste undergoes the necessary treatment, recovery and recycling and thus prevent potential negative effects on the environment and human health which could otherwise arise due to inappropriate waste handling.

V.II.II • In other countries outside th EU

If you wish to discard this product, please contact your local authorities and ask for the correct method of disposal.

For Switzerland:

Used electrical or electronic equipment can be returned free of charge to the dealer, even if you don't purchase a new product. Further collection facilities are listed on the home page of www.swisco.ch or www.sens.ch.

▶ V.III Information on disposal for business user

V.III.I • In the European Union

If this product is used for business purposes and you want to discard it:

Please contact your NORMA dealer who will inform you about the take-back and recycling. Small products (and small amounts) might be taken back by your local collection facilities.

For Spain:

Please contact the established collection system or your local authority for take-back of your used products.

V.III.II • In other Countries outside the EU

If you wish to discard of this product, please contact your local authorities and ask for the current method of disposal.



▲ Attention:

Your product is marked with this symbol. It means that used electrical and electronic products should not be mixed with general household waste. There is a collection system for these products.

User manual

REVO IPA-80



CONGRATULATIONS

First of all, we would like to thank you for the trust you have placed in NORMA. The product you purchased is the result of a long research and development process in which we have put our technical experience, and our passion for music. This products will offer you the best that technology has expressed for high quality sound reproduction. In front of the choice of what to offer as the possibility of customizing the product functions, there are two ways: the first is a simply and immediate user menu, but inevitably with limited possibilities. The second one is wider and able to adapt its functioning (and the sound performance) to the user's desire. Our decision was to offer you the possibility of customization as much as possible the functions that influence the final result. We are sure that you can appreciate this way. In virtue of this, the menus are wide. You will find interesting to read and to study how to use it in detail, in order to better adapt it to your desire. We hope that this manual is clear and that it will answer to each your questions; however we will be pleased to answer to any questions or doubt that you will have. We are confident that you will find great satisfaction from the use of our products, which, if treated with care, will give you lasting reliability. Before use, it is essential to read and learn the entire contents of this document.

1 • Controls and connections

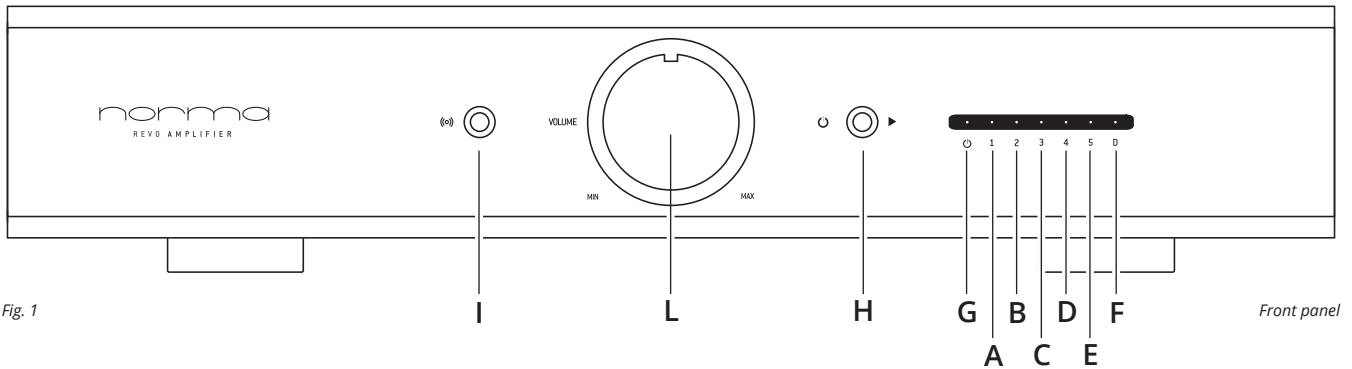

Fig. 1

▶ 1.1 Commands and front indicator list Indicators of input selection

A • IN 1 indicator

If the IN 1 input is selected [also by remote control] the indicator is on.

B • IN 2 indicator

If the IN 2 input is selected [also by remote control] the indicator is on.

C • IN 3 indicator

If the IN 3 input is selected [also by remote control] the indicator is on.

D • IN 4 indicator [PHONO]

If the IN 4 input is selected [also by remote control] the indicator is on.

Input IN 4 can be used as phono input through optional board.

Select this input to use the USB input board.

E • IN 5 indicator

If the IN 5 input is selected [also by remote control] the indicator is on.

Only via IR the IN 5 can be used as REC-OUT, in this way the selected input, with the exception of the direct input DIR, can be send as an output to a recorder.

F • DIRECT indicator [AV IN]

If the input DIR is selected [also by remote control] the indicator is on.

This input is configured as a direct input to the final section. In this case the listening volume is not adjustable by the volume control, but depends only on the level of the input signal.

G • POWER indicator

If the unit is turned on, [even by remote control] the indicator is illuminated at high intensity.

In STANDBY the indicator is illuminated at low intensity.

In case of intervention of the protection circuits the indicator flashes at low intensity.

When the MUTE function is active the indicator flashes at high intensity.

H • SEL Multifunctional control

Selection command used to power on the amplifier and for input selection.

I • Infrared receiver for remote control [IR]

Optical receiving window for the infrared sensor of the remote control.

L • Listening VOLUME control

Control speaker volume. Is also actuated by infrared remote control.

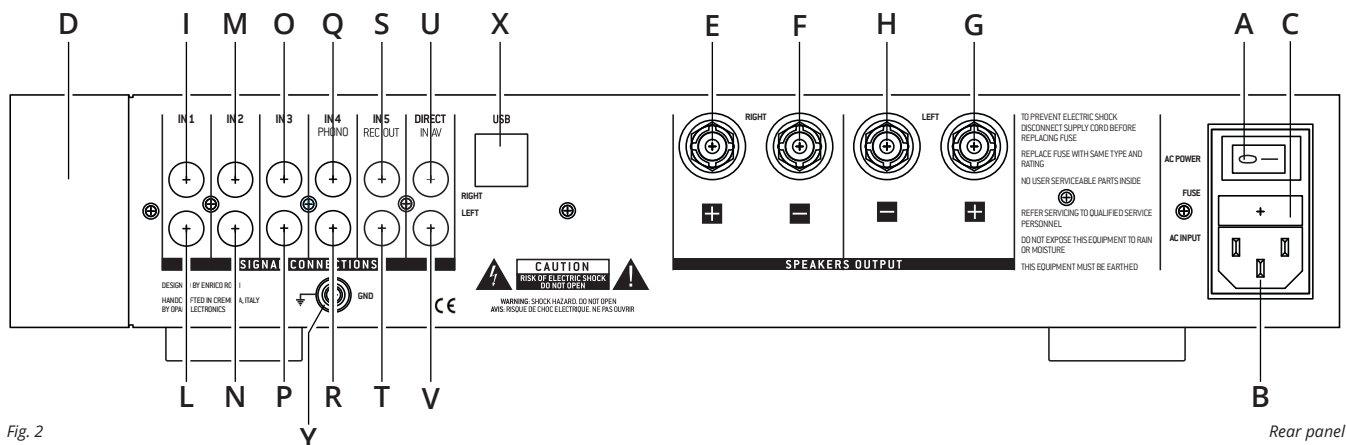

Fig. 2

Rear panel

► 1.2 Controls and rear connections

A • Mains Switch, Power ON / OFF

B • Power connector

AC power inlet. Housing for mains cable connection according to IEC / CEE 22 (VDE C13 connector). Check that the mains voltage corresponds to that indicated on the label on the rear panel.

C • Fuse

AC mains fuse. Verify that the voltage, the type and value coincides with that indicated on the rear panel.

▲ Attention:

For any reason the user must replace the fuse, it is a operation reserved for qualified personnel in the service centers.

D • Heatsink

Device used to dissipate the heat generated by the amplifier.

During normal operation of the amplifier, and for a long time after it is turned off, the heatsink can be very hot and therefore dangerous to touch. Never touch the heatsink during operation and for at least one hour after shutdown.

E • Speakers output [positive] right channel

Output jack for positive power.

F • Speakers output [negative] right channel

Output jack for negative power.

G • Speakers output [positive] left channel

Output jack for positive power.

To connect the speakers use only "Y" fork plugs. Do not use banana plugs, loose or wrapped wires. Short circuit and shock hazard.

H • Speakers output [negative] left channel

Output jack for negative power.

To connect the speakers use only "Y" fork plugs. Do not use banana plugs, loose or wrapped wires. Short circuit and shock hazard.

I / L • IN 1: RCA connection sockets

Input socket for signal IN 1 [phono] channel right / left.

M / N • IN 2: RCA connection sockets

Input socket for signal IN 2 channel right / left.

O / P • IN 3: RCA connection sockets

Input socket for signal IN 3 channel right / left.

Q / R • IN 4 [PHONO]: RCA connection sockets

Input socket for signal IN 4 [Phono or USB] channel right / left. The input IN 4 can be configured as an input for the pick-up [phono] MM / MC by inserting inside the appliance the appropriate form of signal preamplification. If the USB board is fitted you can't use the RCA input 4. When this input isn't used keep it shorted with the supplied RCA shorting plugs.

S / T • IN 5 [REC OUT]: RCA connection sockets

Input socket for signal IN 5 channel right / left. The input IN 5 can be configured (only via remote control), as an output OUT REC; in this way the selected source, with the exception of the direct input DIR, can be sent as an output to a recorder.

U / V • IN DIRECT [AV IN]: RCA connection sockets

This input is configured as a direct input to the final section. In this case the listening volume is not adjustable by the volume control, but depends only on the level of the input signal.

X • USB input B type for digital input

For use with the internal USB DAC stage if fitted [optional].

Y • GND: GND Phono Screw

Ground socket for turntable in the case of use of internal phono stage [optional].

🔍 1.3 Technical notes

1.3.1 • Technical notes about inputs

The REVO IPA-80 amplifier has 6 inputs, 2 of them are configurable by the user.

The input IN 4, as well as being a normal input line, can be configured as a Phono stage input for either MM / MC. The MC stage load can be adjusted internally using the supplied phono stage manual.

The input IN 5, as well as being a normal input line, can also be switched to a fixed REC OUT by the remote control pressing for 5 seconds the "SET" button. If you turn off the amplifier the REC OUT will switch back to IN 5.

The input "AV" (DIRECT) is useful, for example to connect an external audio-video processor, only with integrated volume control (home theatre, TV, DVD player). When this input is selected the volume knob can't control the output level, it depends only on the input signal. NORMA is not responsible of improper use of this input.

1.3.2 • Technical notes about connections

The device must be able to make the most of their features. Nothing in the listening chain should be overlooked, starting with the interconnect cables, which must be of excellent quality, very transparent and neutral. NORMA products are of extremely high quality and will benefit greatly with the use of appropriate cables.

Nothing in the listening chain should be underestimated, from the quality of the cables to the position of the speakers. For example, if cables used are of a low quality, the resulting sound will be much less than the potential of the device.

▶ 1.4 Warm up and run in

The warm up is a fundamental factor. For the best sound performance we recommend an initial run of about 200 to 300 hours of operation with speakers connected and music played at a normal listening level. After a long period of inactivity, the unit will require at least 3 to 4 hours operation to reach the optimum performance levels.

▶ 1.5 The problem of hum

Frequently the connection of multiple devices can cause a certain amount of hum, even when the individual devices are entirely silent. Connecting equipment together can create ground loops which can introduce in the audio signal path a certain amount of network harmonics. This problem, which also affects professional installations, is long-standing and not easy to solve. Its influence is particularly evident in the case of high gain amplifiers and in the presence of signals of very low amplitude. The situation may sometimes be particularly noticeable with phono stages, turntables and cartridges.

We point out some possible remedies:

- Reduce the connection cables length;
- Change signal cables and power cables position;
- Increase the distance between units, or arrange them in a different way;
- Avoid using devices that can induce electromagnetic fields or interference, such as electric motors, fluorescent lights or halogen lamp low voltage transformers;
- It may be useful to increase the signal connection shielding from one side of the termination. If a device proves to be involved in hum problems and / or ground loops contact the manufacturer to try to solve the problem;
- The electrical safety is due to its connection to safety ground. Before connecting and using the device, make sure that the grounding system is efficient. NORMA is not responsible for any damage caused resulting from wrong system grounding, or failure to follow safety procedures and regulations or a disconnection made in any way to the ground security equipment;
- Check that the mains power cable has a ground connection and do not remove it, for any reason;
- LED TV's or PLASMA TV's emit large amounts of infrared rays that can interfere with the IR remote control signal;
- Most of the Revo IPA-80 produced since 2020 have an internal DC filter in order to eliminate the DC offset on the mains, normally this feature is disabled. For DC filter activation contact NORMA or your supplier.

2 • Start to use

▶ 2.1 NORMA IR remote description

The IR remote can access all operating functions, also contains controls for volume setting, built at two speeds, standard (fast, VOL - - / VOL + +) and fine (slower VOL - / VOL +) . On the remote control is also present the MUTE key that completely mutes the output signal. This condition is indicated by the flashing of the POWER indicator to high intensity.

Some of the controls on the remote IR may be inactive, reserved for future uses.

→ See Remote controls manual at page 17.

▶ 2.2 Turn ON / OFF

The REVO series amplifiers are equipped with a sophisticated power on system, integrated with the system remote control and electronic protections. This system consists of three phases: POWER OFF, STAND-BY, POWER ON [OPERATE].

2.2.1 • Power OFF

In this phase, the rear control switch is in the OFF position and the amplifier is off.

2.2.2 • Power OFF to standby

Placing the rear control switch in the ON position, the amplifier is active in STAND-BY POWER indicator on the front panel will be on with a low intensity. This condition can be maintained indefinitely, the amplification stages are not powered, but the amplifier is ready to receive the command switch.

2.2.3 • Power ON [operate]

The power is on to all intents and purposes, this can be determined by the prolonged action on the front SEL button or IR remote POWER button. In both cases, initially the indicator flashes for a period of time equal to approximately 10 seconds. Subsequently, the light indicator turns solid, indicating the complete operation of the amplifier and the connection to the speakers.

2.2.4 • Power ON to standby

To put the amp in STANDBY mode, press the SEL button [or the POWER button on the remote control], the indicator will switch to low-intensity lighting.

2.2.5 • Standby to power OFF

To POWER OFF the amplifier, press the POWER button, on either the remote control or the front panel of the amp, and then put the rear control switch into the OFF position. Never work directly on the rear control without first placing the amplifier into STANDBY.

▶ 2.3 Protection circuit

Inside the amplifier REVO IPA-80 there are some sophisticated protection circuits that control the

temperature of the heatsinks, the presence of any offset current exceeding the limit value and the abnormal supply of output current (short circuit).

2.3.1 • Thermal protection

In case of activation of the thermal protection the amplifier will automatically shut down and the power indicator lights will go completely off. The amplifier cannot be turned back on until the temperature has returned to the correct value, and this will be indicated by the POWER light in a low intensity. Only then can you repeat the POWER ON procedure. The amplifier will not automatically restore the last used state.

2.3.2 • DC offset protection

In case of protection for the presence of a DC component in the output signal, the amplifier will turn off and the power indicator switches to low intensity flashing. You can turn it back on only after switching off the appliance at the rear and leaving it off for at least 10 seconds. If the fault persists, the amplifier will run again in protection mode. In this case disconnect all signal cables and repeat the process of restarting the unit. Should the situation persist, contact your service representative. The amplifier will not automatically restore its original state.

▶ 2.4 Inputs selection

Input selection takes place with a quick tap on the multi-function control SEL switch. The inputs will be selected in sequence IN 1, IN 2, IN 3, IN 4, IN 5, DIRECT. It is possible to select the required input using the remote control or via direct access with the numeric keys 1 - 5 or in sequence with the SEL - / SEL +. For added convenience, the REVO series amplifiers have a resume function [the state saved before shutting down], so that for each start (from STAND-BY) the amplifier is ready to use the input selected before turning off. The stored configuration is lost if you turn off the main power.

▶ 2.5 Selection of REC output

REVO series amplifiers have the ability to connect a recorder to the output REC OUT. It is possible to activate and deactivate this connection only via remote control with the prolonged action on SET (or short action on REC button, if present) button on IR remote control. In order to not introduce any noise, we recommend you keep the REC OUT under OFF whenever it is not in use.

▶ 2.6 Selection of direct input (AV IN)

This input is configured as a direct input to the final section, for example to connect to an external Audio Video processor. It is activated by remote control by pressing the 6 key or by sequential selection. Selecting this input, the listening volume is not adjustable by the volume control, but depends only on the level of the input signal. Pay attention to the input level, To avoid sending too much power to the speaker.

3 • Maintenance

▶ 2.7 Listening volume control

The listening volume can be adjusted by the front knob or the remote control, using the function keys VOL - / VOL + (fine tuning) or VOL - - / VOL + + (quick adjustment). To avoid damage to your speakers, before turning on we recommend to always turning the control fully counter clockwise to MIN. It is also advisable to set the volume to a minimum during each input selection and/or change of connection.

▶ 2.8 Connecting the speakers

The speakers are connected by cables to the SPEAKERS OUTPUT sockets. Cables must be of adequate quality (at least 4 mm ²).

In addition:

- The connection cables must have the same length for both channels even if the distance between the speakers and the amplifier is different;
- The cables must not be piled up or rolled;
- Safety regulations require that the cables must not be pushed into or wrapped around the 4mm banana plug sockets of the amplifier;
- In order to not overload the amplifier, the speaker impedance cannot be lower than 4 ohms;
- The speakers should not be connected in parallel with each other.

▲ Caution:

To prevent damage, each connection must be carried out when the appliance is switched off and unplugged from the mains.

▶ 3.1 Cleaning

Before cleaning the unit, turn it off and unplug it from the electricity supply and wait at least 10 minutes. Your device has been designed with the best technical solutions combined with an aesthetic finish of the highest quality, but for it to remain unchanged over time, it is essential to observe the following procedures:

- Do not dry-clean surfaces and in particular the front panel;
- Lightly dampen a cloth with a small amount of warm water (40 - 50 degrees);
- Make circular movements and do not press hard on the panel;
- Dry off gently, always with cotton or a soft cloth, using a very delicate circular motion;
- Be very careful to avoid that no water penetrates into the unit, the cloth should be moist but not wet;
- Do not reconnect the unit until it is completely dry;
- Under no circumstances use alcohol, solvents, petrol or any type of chemical product;
- Please note that the finish and aesthetic components are in no way covered by the warranty.

▶ 3.2 Repairs

For any issues please refer to the safety manual. NORMA products are the result of precision engineering with sophisticated circuitry and extremely high-quality components. In the unlikely event of failure, make sure to refer to a highly qualified assistant that has genuine original spare parts. NORMA is contactable for any customers who have an issue which needs to be resolved. NORMA is not responsible for any errors, omissions or incompleteness of this manual, and is not responsible for accidents or damage of any kind that may result from non-compliance, even partial, of the information provided in this manual. Despite the effort to identify all possible situations, NORMA is not responsible for any damage that may be caused to people or from improper use.

Aux overview

REVO IPA-80



CAUTION

RISK OF ELECTRIC SHOCK
DO NOT OPEN



WARNING:

As indicated in the safety manual, we remind you that the actions described below must be performed only by highly qualified personnel. There are very high and dangerous electrical voltages inside the device. It also exists at the possibility of damaging the product and the other components connected to it in case of wrong operations. We are not responsible for any type of injury or damage due to incorrect operation.

4 • Aux overview

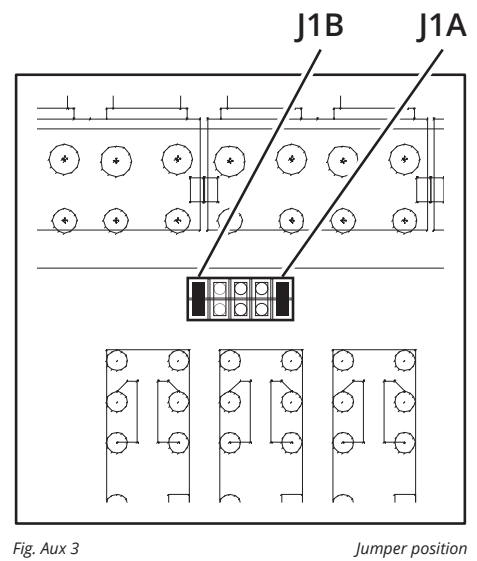
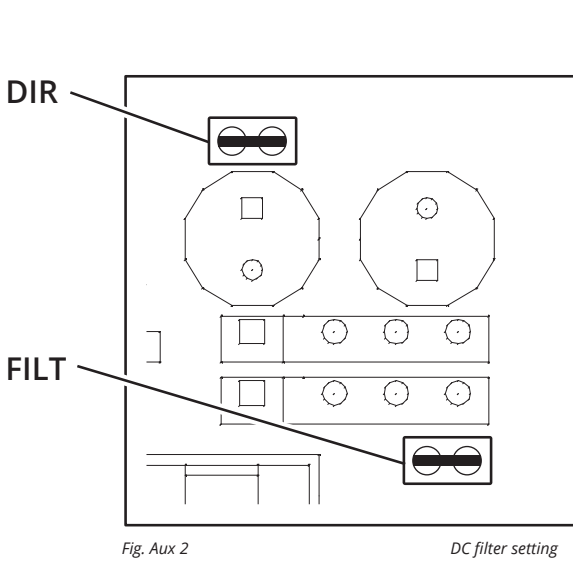
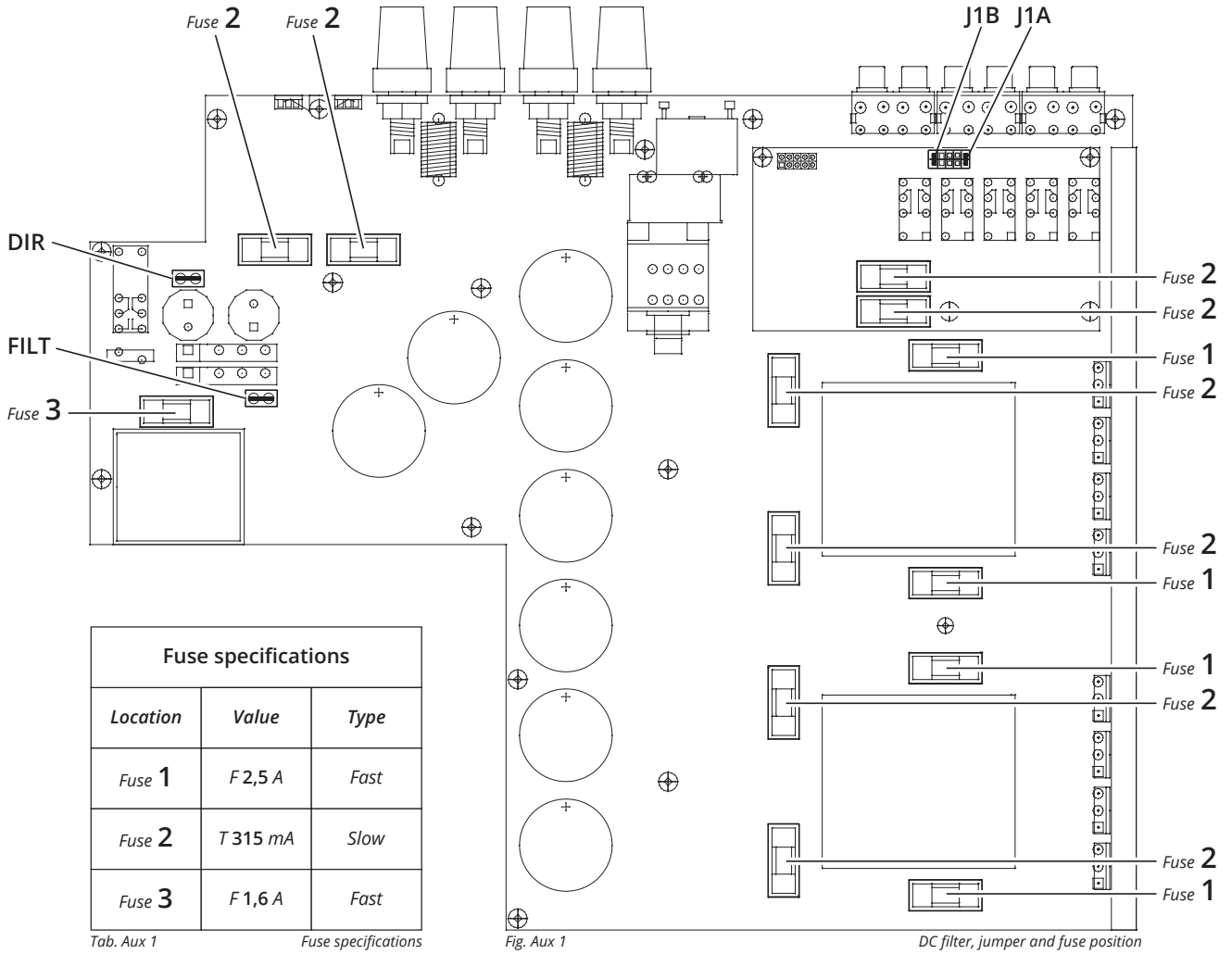

► 4.1 Output - input configuration

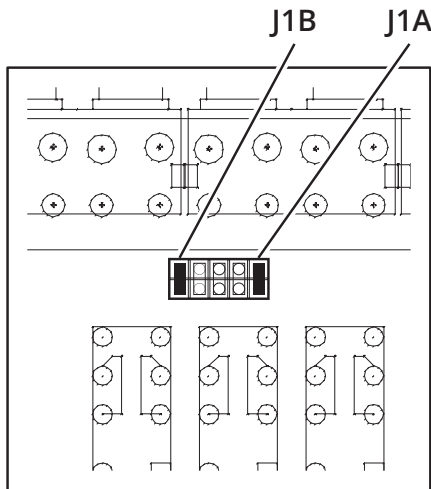

Fig. Aux 3

Jumper position

Default configuration

| Note | Description | J1A | J1B |
|------|----------------------------|-----|-----|
| 1 | Default, IN4 as LINE Input | YES | |

Tab. Aux 2

Default configuration

Phono input configuration

| Note | Description | J1A | J1B |
|------|--|-----|-----|
| 2 | IN 4 as PHONO Input or USB module fitted | NO | |

Tab. Aux 3

Phono input configuration

The Jumpers J1A, J1B are located under the optional phono board or under the USB board, if one of those boards is fitted and you have to operate under that you have to remove it. Some spare jumpers are supplied in the spare fuse bag, attached to the device instruction manual.

1 • Default configuration

When J1A and J1B are fitted the input IN4 is a normal LINE input.

2 • Phono input configuration

If you want to fit an optional phono board or an USB board you have to remove both the jumpers.

▲ Caution:

When you insert the PHONO board or the USB board, be sure that jumpers J1A- J1B are removed, otherwise may arise problems caused by the self-oscillation of the board.

🔍 Note:

when the USB board is fitted the Input IN4 cannot be used as a LINE input.

▲ Caution:

The configuration of the inputs involves the removal of the top cover, therefore it is a potentially dangerous operation. It must be carried out by qualified personnel in compliance with all safety

standards. In particular, but not only, the device must be disconnected from the mains and disconnected from any other equipment, must be turned off for at least 30 minutes and you must make sure that all capacities are discharged. To be sure that the capacitors are discharged there are 8 LEDs on the main board, if the LEDs aren't lit the capacitors are completely discharged. If the configuration jumpers is incorrect, the amplifier can enter into self-oscillation, this may cause damage to the speakers and the amplifier itself. Use extreme caution and possibly connect the speakers after checking the correctness of the configuration. We are not responsible for wrong or partial configurations of these jumpers.

4.1.1 • Fuse replacing

Supplied with this device there is a small bag with some spare screws, jumpers and fuses. If a fuse blows up there is the possibility of replacing it but only with the same type, voltage rating, current rating and most importantly the action speed (slow "T" or fast "F").

▲ Caution:

Never bypass a fuse and never replace a blown fuse with a different one. This may cause fire and electric shock. We are not responsible for any injury or damage due to a wrong fuse replacing or any type of tampering.

4.1.2 • DC filter

If you want to activate the DC filter you have to disconnect the female Faston connector from the male plug DIR, then connect it to the male plug FILT. This operation must be carried out only with the power cable disconnected from the mains.

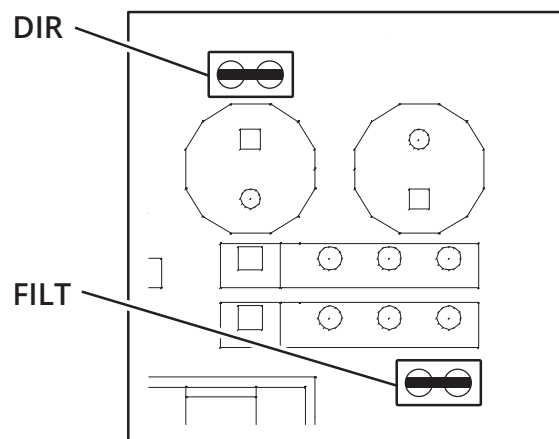

Fig. Aux 2

DC filter setting



Caution: shock hazard, this part of the circuit is directly powered from the mains and its capacitors could hold the charge for long time after the shutdown. Disconnect this unit from the mains and wait at least 30 minutes before opening the top cover. The operation must be carried out only by qualified personnel authorised service centers. We are not responsible for any injury or damage due to a wrong operation.

PH1 phono

Optional

5 • Phono stage - PH1 phono

► 5.1 Setting and user notes

The NORMA PH1 phono allows for a series of fine settings and options, in order to achieve the best connection with turntables.

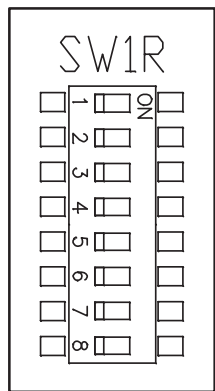
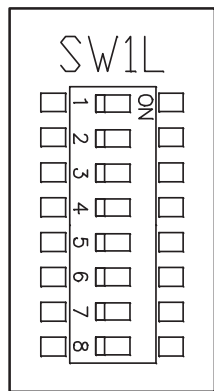
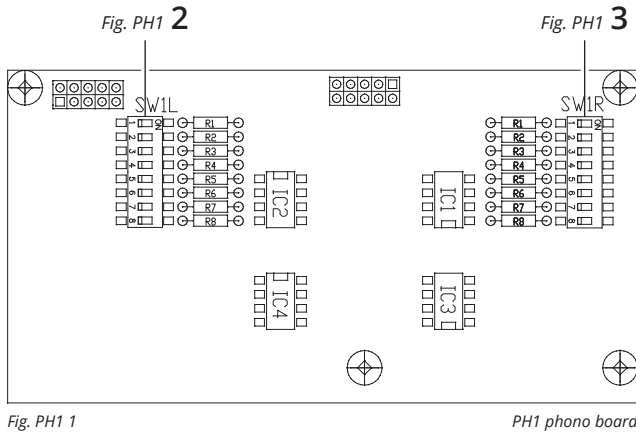

5.1.1 • Input impedance

Settings are obtained via micro-switches 1 - 4 on the PCBs SW1L and SW1R, respectively for the right and left channels, as shown in Fig. PH1 2 and Fig. PH1 3 at page 12. To activate the desired impedance value, put the corresponding micro-switch in the ON position, leaving all the other switches (1 - 4) in the OFF position. If no switches are turned on, the default settings are used, 47 Kohm e + 34 dB.

🔍 Notes:

- The default impedance value is 47 Kohm, with no switch turned on.
- The SPARE position is meant for customization. If you need a specific resistance value, please contact NORMA.

| SW 1L • SW 1R - Input impedance | | |
|---------------------------------|--------|------|
| Position | Value | Unit |
| 1 | 100 | Ohm |
| 2 | 510 | Ohm |
| 3 | 1.000 | Ohm |
| 4 | Spare | // |
| All OFF | 47.000 | Ohm |

Tab. PH1 1

Input impedance value

5.1.2 • Gain

Settings are obtained via micro-switches 5 - 8 on the PCBs SW1R and SW1L, respectively for the right and left channels, as shown in the pictures on page two.

To activate the desired gain value, put the corresponding micro-switches in the ON position, as shown in Fig. PH1 2 and Fig. PH1 3 at page 12. If no switches are turned on, the default settings are used, 47 Kohm e + 34 dB.

🔍 Notes:

- The default gain value is + 34 dB, with no switch turned on.
- The SPARE position is meant for customization. If you need a specific gain value, please contact NORMA.

| SW 1L • SW 1R - Gain | | |
|----------------------|-------|------|
| Position | Value | Unit |
| 5 | Spare | dB |
| 8+7+6 | +52 | dB |
| 6 | +50 | dB |
| 8+7 | +46 | dB |
| 7 | +42 | dB |
| 8 | +38 | dB |
| All OFF | +34 | dB |

Tab. PH1 2

Gain value

🔍 5.2 Notes

1 • To achieve a custom value for impedance and gain, a custom resistance has to be inserted in SPARE positions (1 and 5). To know what resistance value needs to be used, please contact NORMA;

2 • In case you use a MC pickup with a low output and low load impedance, it could be useful, to obtain better performances in terms of noise, to exchange one of the 2 Integrated Circuits (ICs) used for both channels.

The default setting (which is ready to work with MM pickups) uses an OPA604 for both the first gain stage and the second gain stage.

Since those ICs are mounted on a base, they can be easily swapped.

To set the board for MC operation, you can remove the first gain stage OPA604 (IC1 - IC2) and install an LT1115 (as provided in the spare fuses packages in the user manual).

Please note that polarity must be respected.

For any further information, please contact NORMA;

3 • To connect the turntable to ground there is an M3 screw is on the back of the amplifier.

USB board

Optional

6 • USB connection

▶ 6.1 USB board specification

- **Audio format:** PCM max 192 kHz, DSD max 64xf;
- **Digital to Analog Converter:** Wolfson WM 8741 DAC;
- **USB interface:** 2.0 High Speed;
- **USB receiver firmware:** AMANERO.

▶ 6.2 Warnings

In order to avoid unexpected behaviors there are some warnings about the sampling frequency and the DSD protocol.

6.2.1 • DSD protocol warning

The USB board and converter of the IPA-80 are compatible with DSD64 files.

The ONLY transmission protocol supported is “DSD over PCM”. Do NOT use any other transmission protocol for DSD, this could result in serious damage, as it transmits signals that are not recognized by the device, and could therefore be interpreted in non-predictable ways.

6.2.2 • Upsampling warning

The REVO IPA-80USB board works until 192 KHz. If signal is streamed at higher frequencies, the board will not recognize it as a workable signal, and will therefore mute the output. Please remember to deactivate any up-sampling above 192 KHz.

The world of computers and digital file playback is constantly evolving.

Moreover, the complexity of related and interdependent topics is very wide and constantly changing

So it is hard (if not impossible) to write an exhaustive guide on how to properly use them in order to achieve the best sound performance.

The user is responsible for having the necessary knowledge to properly use this type of devices.

NORMA can't be held responsible to eventual problems, malfunctioning or damages caused by a improper use of informatic resources and their interfacing.

We trust in your information technology knowledge.

There are several softwares and protocols so the software type and the software settings are at your discretion, we don't recommend a specific one, you can achieve a good sound performance with any type of software player.

In statistical terms, in 99% of cases apparent faults are due to a wrong or incomplete software setting

If the USB unit doesn't work, always check:

- The connection between the PC and the amplifier;
- The correct driver installation, including the correct OS version, the hardware compatibility and check always the driver updates;
- Check if your player can see the USB audio connection;
- Check your player configuration, in particular the output settings;

- Check if your software player doesn't oversample over 192 kHz, if a frequency up to that value is detected the USB board will mute the output;

- Do not play any file with a frequency over 192 kHz and DSD over x64;

- Check the ASIO / WASAPI driver configuration if present in your SW player.

We are not responsible for any improper use of this device.

7 • Specifications

REVO IPA-80

| | |
|---|--|
| Description | Stereo Integrated Amplifier; |
| Input Connections | 6 RCA (5 Line, 1 Direct); |
| Input Optional Configuration | IN 4 Phono, IN 5 Rec Out; |
| Input Impedance RCA (selected input) | 10 k Ω ; |
| Input Impedance RCA (non selected input) | Open; |
| Sensitivity | 465 mV (80 W / 8 Ω); |
| Input Selection Type | Electromechanical, by Gold contact Cross bar relay; |
| Output Connections | 1 RCA (Rec Out), selectable by remote control; |
| Speakers Connections | 2 pair of 4mm binding post for banana plugs and Y forks; |
| Output RMS Power (8Ω) (each channel) | 80 W; |
| Output RMS Power (4Ω) (each channel) | 150 W; |
| Output Rated Current (each channel) | 24 A; |
| Output Peak Current (each channel) | 100 A; |
| Minumum Speaker Impedance | 4 Ω ; |
| Frequency Response | 0 - 800 kHz (- 3 dB non filtered); |
| Gain (Volume at MAX) | 40 dB (28 mV - 1 W / 8 Ω); |
| Internal Circuitation | Solid State; |
| Output Stage | 2 pair of MOSFET each channel; |
| Volume Control | ALPS Motorized Potentiometer; |
| Possible Optionals for this unit | Phono board, USB DAC board (Phono board and USB not both fitted), DC Filter for AC power supply; 100 - 510 - 1 k - 47 k Ω , + custom value, selectable by dip switches; + 34 ÷ + 52 dB + custom value; |
| Phono stage Load | MM-MC; |
| Phono Stage Gain | USB 2.0 HI-Speed; |
| Supported Pick.up Types | Amanero; |
| USB Receiver Interface | PCM: Max 192 kHz, DSD: Max 64 Xf; |
| USB Firmware | PCM: 44,1 / 88,2 / 176,4 kHz, PCM: 48 / 96 / 192 kHz, DSD: 64 Xf; |
| Audio format | 1x Wolfson WM8741; |
| Supported Sampling Frequencies | 230 V (115 V in some countries); 50 Hz (60 Hz in some countries); 1.6 AT; |
| DAC Device (IC) | 1 toroidal transformer for audio applications, 300 VA; |
| Power Supply Voltage | Capacitive; |
| Power Supply Frequency | 8; |
| Power Supply Fuse Rating | Electrolytic, Total 37500 μ F; |
| Electric transformer/s | 90x440x360; |
| Filtering | 220x550x450; |
| N° Capacitors | 15Kg. |
| Capacitors type | |
| Dimensions (HxWxD) [mm] | |
| Carton Box Size (HxWxD) [mm] | |
| Weight [Kg] | |

 In order to improve its products, NORMA reserves the right to change technical specifications and appearance without notice.

Remote controls

REVO IPA-80

8 • Aluminium remote RC-43 / 31

🔍 Note:

For further information regarding the use and the maintenance of this remote, please visit our website at www.normaudio.com

▶ 8.1 Inserting the batteries

- Our IR remotes are provided with included batteries but not fitted in to prevent the discharging due to an eventual stocking time or if a button were pushed during the transport. This remote works only with a set of three CD2032 batteries, as provided in the packaging. Do not use any other type of battery, as this could result in damage for the unit;

- First of all, to access the battery compartment, you will have to remove the back panel. In order to do so, pick the screwdriver provided in the packaging, unscrew the screws, and then remove the back panel;

- Be careful not to scratch the panel with the screwdriver;

- The positive battery pole must be in the upper side and the negative one is on the lower side;

▲ Caution:

- Please respect the polarity;

- The fork spring on the side is designed to hold down the battery, so don't push that down, the remote control won't work;

- Pay attention because that spring is very delicate and it's easy to push that under the battery;

- To insert the battery put the positive pole under the fork and then push the battery in the holder.

DO NOT force the batteries when inserting.

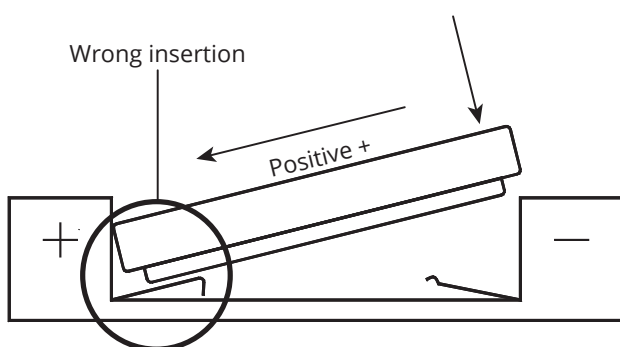
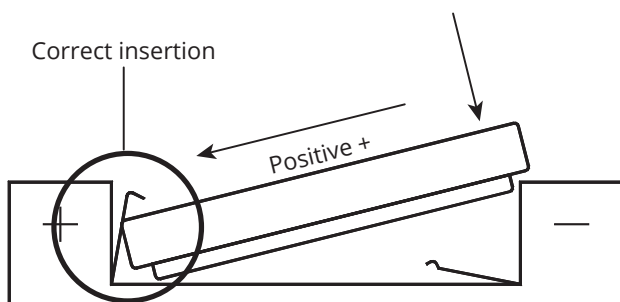

Fig. IR 1

Inserting the batteries

▶ 8.2 Removing the batteries

- If the unit is left unused for long periods of time, it is better to remove the batteries, to avoid their discharge and possible damages to the unit;

- To remove the batteries, access the battery compartment as explained in the previous paragraph. Then, pick the appropriate tool from the packaging, as shown in FIG. IR 2, and gently insert it on one side of the battery holder. Then, apply a slight pressure, in order to allow the battery to come out. Repeat this operation for all batteries, then screw the back panel on again;

- Do not try to extract the battery with hands, this could cause serious damage to the battery holder and to the unit. Use the provided thumbtack as shown on the FIG. IR 2.

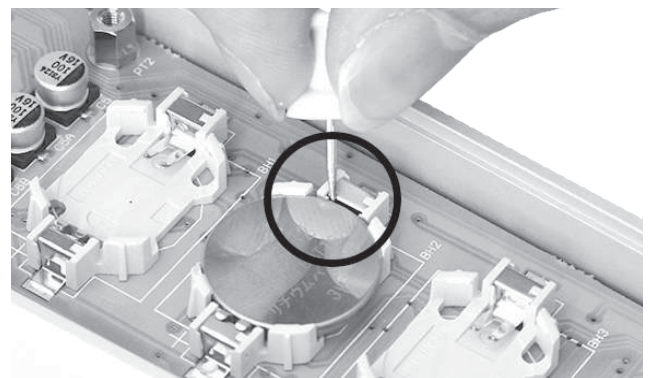

Fig. IR 2

Removing batteries detail

▶ 8.3 Troubleshooting

If the remote control doesn't work, often it's an apparent fault and it could be due to:

- Wrong battery insertion. (positive and negative poles swapped) check it carefully;

- Positive terminal pushed down: if the battery has been inserted badly the positive fork spring could have been pushed down so the battery doesn't make the contact and the remote control doesn't work;

- Mode not selected (ex. DIG-AMP-CD). Press the corresponding button to select the desired mode and then try to send a command to the device.

🔍 Note:

An abnormal functioning of your NORMA device could be due to an IR interference, coming from Plasma TVs, PC monitors or different remote controls.











▶ 8.4 Battery recycling



If you have to replace a discharged battery absolutely do not waste it into the rubbish bin. It's a special waste and it must be given to a recycling center. Batteries and electric components are dangerous for the environment so don't throw them away or with the normal waste.

9 • Remote controls description

► 9.1 IR-31 AMP remote control: commands list, general description

| <i>Symbol</i> | <i>Command</i> | <i>Description</i> |
|---|----------------|---|
| AMP | MODE | Sets remote control on AMP MODE (for REVO IPA-80 / REVO IPA-140 / REVO SC-2 / HS-IPA1) |
| DIG | MODE | Sets remote control on DIG MODE (for DACs / HS-DA1 & REVO-DAC1) |
|  | POWER ON-OFF | Turns the unit ON and OFF |
| MENU | MENU | Enters the menu setup configuration |
| OK | OK | Confirms the selection in MENU |
| CLEAR | CLEAR | Moves back to upper level in MENU |
|  | NEXT | Moves forwards in MENU (direct Input selection on REVO IPA-80 / REVO IPA-140) |
|  | BACK | Moves backwards in MENU (direct Input selection on REVO IPA-80 / REVO IPA-140) |
|  | VOL. UP FAST | FAST volume UP (direct volume UP control on REVO IPA-80 / REVO IPA-140 / REVO SC-2 / HS-IPA1) |
|  | VOL. DOWN FAST | FAST volume DOWN (direct volume DOWN control on REVO IPA-80 / REVO IPA-140 / REVO SC-2 / HS-IPA1) |
| VOL + | VOL. UP FINE | FINE volume UP |
| VOL - | VOL. DOWN FINE | FINE volume DOWN |
|  | MUTE | MUTE / UNMUTE the output audio signal |
| IN | IN | Enters the INPUT SELECTION menu (on REVO SC-2 / HS-IPA1 / HS-DA1) |
| DAC | DAC | Enters the DAC menu (on REVO SC2+DAC / HS-IPA1+DAC) |
| 1 – 8 | NUMBERS (1-8) | Selects a NUMBER (quick inputs selections on REVO IPA-80 / REVO IPA-140) |
| F1 | F1 | Generic function, customized for the various devices (phase on DACs) |
| F2 | F2 | Generic function, customized for the various devices |
| A/P | A/P | Toggles active or passive mode (preamplifier REVO SC-2 only) |
| DY | DY | Changes the display light (customized for various devices) (light 30-100 % ON / OFF) |
|  | PLAY | Starts the CD playback (this command is always sent to the REVO CDP+DS-1 in any MODE) |
|  | STOP | STOP CD playback (this command is always sent to the REVO CDP+DS-1 in any MODE) |
|  | NEXT | Skips to NEXT track (this command is always sent to the REVO CDP+DS-1 in any MODE) |
|  | PREVIOUS | Skips to PREVIOUS track (this command is always sent to the REVO CDP+DS-1 in any MODE) |

Tab. IR 1





IR-31 AMP general description

Note:

For a complete description of the meaning and use of the various commands, refer to the user manual of the single model.

This model can be used with two types of products, amplifiers and DACs. To use it with amplifiers, press the **AMP** button before using the remote control to send commands. The remote control remembers this selection until the batteries are full; therefore it is not necessary to press each time. If the **DIG** key is inadvertently pressed, the commands are routed to the DACs. In this case, simply press the **AMP** command again. Similarly, to control the DACs (eg HS-DA1 or REVO-DAC1), press the **DIG** key first.

► 9.2 IR-31 AMP remote control: commands list for REVO IPA-80 / REVO IPA-140

| <i>Symbol</i> | <i>Command</i> | <i>Description</i> |
|---|----------------|---|
| AMP | MODE | Sets remote control on AMP MODE (for REVO IPA-80 / REVO IPA-140 / REVO SC-2 / HS-IPA1) |
| DIG | MODE | Sets remote control on DIG MODE (for REVO-DAC1 / HS-DA1) |
|  | POWER ON-OFF | Turns the unit ON and OFF |
| MENU | MENU | Enters the menu setup sonfiguration, In REVO IPA-80 this command, long press (2s), enable the TAPE OUTPUT |
| OK | OK | Not used in this model |
| CLEAR | CLEAR | Not used in this model |
| ► | NEXT | Quick input selection, selects the next input |
| ◄ | BACK | Quick input selection, selects the previous input |
|  | VOL. UP FAST | FAST volume UP |
|  | VOL. DOWN FAST | FAST volume DOWN |
| VOL + | VOL. UP FINE | FINE volume UP |
| VOL - | VOL. DOWN FINE | FINE volume DOWN |
|  | MUTE | MUTE / UNMUTE the output audio signal |
| IN | IN | Not used in this model |
| DAC | DAC | Not used in this model |
| 1 – 6 | NUMBERS (1-6) | Quick inputs selections |
| 7 – 8 | NUMBERS (7-8) | Not used in this model |
| F1 | F1 | Not used in this model |
| F2 | F2 | Not used in this model |
| A/P | A/P | Not used in this model |
| DY | DY | Not used in this model |
| ▶ | PLAY | Starts CD playback (this command is always sent to the REVO CDP+DS-1 in any MODE) |
| ■ | STOP | STOP CD playback (this command is always sent to the REVO CDP+DS-1 in any MODE) |
| ▶▶ | NEXT | Skips to NEXT track (this command is always sent to the REVO CDP+DS-1 in any MODE) |
| ◀◀ | PREVIOUS | Skips to PREVIOUS track (this command is always sent to the REVO CDP+DS-1 in any MODE) |

Tab. IR 2

IR-31 AMP for REVO IPA-80 / REVO IPA-140

🔍 Note:

For a complete description of the meaning and use of the various commands, refer to the user manual of the single model. Remember to press **AMP** before use.

Shortcut for input selection mode:

The input selection is possible in two ways, one sequential **(1)** and one direct **(2)**.



1 • Press ► or ◄;

2 • Press 1 – 5

(5 in the case of REVO IPA-80, 6 in the case of REVO IPA-140USB with USB option).

► 9.3 IR-43 system remote control: commands list, general description

If you have 2 or more NORMA products and you want to control them with a single remote control, you can request IR-43 remote control from NORMA.

| <i>Symbol</i> | <i>Command</i> | <i>Description</i> |
|--|----------------|--|
| AMP | MODE | Sets remote control on AMP MODE (for REVO IPA-80 / REVO IPA-140 / REVO SC-2 / HS-IPA1) |
| CD | MODE | Sets remote control on CD MODE (for REVO CDP+DS-1) |
| DIG | MODE | Sets remote control on DIG MODE (for REVO-DAC1 / HS-DA1) |
| AUX | MODE | Sets remote control on AUX MODE (spare) |
|  | POWER ON-OFF | Turns the unit ON and OFF |
| MENU | MENU | Enters the menu setup configuration |
| OK | OK | Confirms the selection in MENU |
| CLEAR | CLEAR | Moves back to upper level in MENU |
| ▶ | NEXT | Moves forwards in MENU (direct input selection on REVO IPA-80 / REVO IPA-140) |
| ◀ | BACK | Moves backwards in MENU (direct input selection on REVO IPA-80 / REVO IPA-140) |
|  | VOL. UP FAST | FAST volume UP (direct volume UP control on REVO IPA-80 / REVO IPA-140 / REVO SC-2 / HS-IPA1) |
|  | VOL. DOWN FAST | FAST volume DOWN (direct volume DOWN control on REVO IPA-80 / REVO IPA-140 / REVO SC-2 / HS-IPA1) |
| VOL + | VOL. UP FINE | FINE volume UP |
| VOL - | VOL. DOWN FINE | FINE volume DOWN |
|  | MUTE | MUTE / UNMUTE the output audio signal |
| IN | IN | Enters the INPUT SELECTION menu (on REVO SC-2 / HS-IPA1 / HS-DA1) |
| DAC | DAC | Enters the DAC menu (on REVO CDP+DS-1 / REVO SC-2+DAC / HS-DA1 / HS-IPA1+DAC) |
| 0 – 9 | NUMBERS (0-9) | Selects a NUMBER (quick inputs selections on REVO IPA-80 / REVO IPA-140) or (track on REVO CDP+DS-1) |
| F1 | F1 | Generic function, customized for the various devices (digital phase on REVO CDP+DS-1 & DACs) |
| F2 | F2 | Generic function, customized for the various devices |
| F3 | F3 | Generic function, customized for the various devices |
| A/P | A/P | Toggles active or passive mode (preamplifier REVO SC-2 only) |
| DY | DY | Changes the display light (customized for the various devices) (light 30-100 % ON / OFF) |
| DV | DV | DIGITAL VOLUME setting, only in REVO CDP+DS-1 in DAC mode with SRC enabled |
| ▶ | PLAY | Starts the CD playback (this command is always sent to the REVO CDP+DS-1 in any MODE) |
| ⏸ | PAUSE | PAUSE CD playback (this command is always sent to the REVO CDP+DS-1 in any MODE) |
| ■ | STOP | STOP CD playback (this command is always sent to the REVO CDP+DS-1 in any MODE) |
| ⏭ | NEXT | Skips to NEXT track (this command is always sent to the REVO CDP+DS-1 in any MODE) |
| ⏮ | PREVIOUS | Skips to PREVIOUS track (this command is always sent to the REVO CDP+DS-1 in any MODE) |
| ⏩ | FAST FORWARD | Fast forwards track (this command is always sent to the REVO CDP+DS-1 in any MODE) |
| ⏪ | REWIND | Rewinds track (this command is always sent to the REVO CDP+DS-1 in any MODE) |
| ▲ | OPEN / CLOSE | Opens / closes the CD tray (this command is always sent to the REVO CDP+DS-1 in any MODE) |
| REPEAT | REPEAT | Activates automatic repeat (this command is always sent to the REVO CDP+DS-1 in any MODE) |
| TIME | TIME | Changes the time indication shown on CD display (elapsed – remaining) |

Tab. IR 3

IR-43 general description

🔍 Note:

For a complete description of the meaning and use of the various commands, refer to the user manual of the single model, refer also at IR-31 model. Remember to press correct **MODE** before use.

Warranty

REVO IPA-80

10 • Warranty conditions

We hereby acknowledge to the NORMA product specified below the warranty lasts 2 (two) calendar years from the sale date of this product. The terms which regulates the warranty are written below and they are integral part of this certificate.

► 10.1 Object of warranty

The warranty only covers the product shown on the registration module (also downloadable from NORMA website) which forms an integral part of this document, as well as the accessories related to it, provided that they are purchased at the same time.

► 10.2 Warranty content

- NORMA will, at its option, repair or replace the product covered by this warranty if it becomes defective, malfunctions or otherwise fails to conform with this warranty under normal use and service during the term of this warranty. Without charge for labor or materials. Repairs may be performed using new or refurbished parts that meet or exceed NORMA specifications for new parts;

- Damages and injuries (direct or indirect) of any nature and title, deriving from faults and malfunctioning won't be covered from this warranty. The warranty will cover only the NORMA product repair.

► 10.3 Limited warranty range

- The warranty period starts from the time of purchase. In the event of a deferred payment, the application of the warranty will be guaranteed unless the payment is successfully completed.

In the event that the agreed payment is not respected (amounts and / or expirations), NORMA reserves itself the right to modify, suspend or delete the warranty. In case of deferred payment the warranty expiration could precede the payment expiration;

- The warranty will be valid only after the product registration within the maximum term of 30 calendar days from the purchase date, using the registration module that is an integral part of this document (also downloadable from NORMA website). That module must be compiled in each part and followed by the sales document. The sales document must have fiscal validity (fiscal ticket, invoice or receipt) proving date, place of sale, amount and retailer name. The retailer must stamp at the bottom the registration module. In any case the warranty won't be applied to appliances whose owners have not fulfilled the above formalities;

- NORMA products are very sophisticated, these products must be used and installed only by subjects with adequate knowledge and experience related to the installing and using procedures;

- Warranty void if the user doesn't observe all the indications reported in the relative safety and user manual;

- Warranty will be provided only in NORMA venue. The shipping costs are charged to the customer both outward and return, so as the shipping risks. The eventual insured shipping doesn't constrain NORMA to any type of responsibility related to the shipping risks;

- NORMA products are designed only for personal entertainment, then the warranty covers only the defects due to a private household use and it doesn't cover:

- *Any unit which has been altered or on which the serial number has been defaced, modified or removed;*

- *Normal wear, battery or battery replacement and any periodic maintenance;*

- *Deterioration due to corrosive atmosphere or other external causes such as extremes in temperature or humidity;*

- *Damages attributable to power line surge or related electrical abnormalities, lightning damage or abnormal atmospheric acts as well as phenomena of transmutation of the atom or radiation caused by the artificial acceleration of atomic particles;*

- *RFI / EMI (Interference / noise) caused by improper grounding or the improper use of either certified or uncertified equipment, if applicable;*

- *Interference arising from the use of wireless communication devices (e.g. 2.4 GHz cordless telephones), or other radio frequency emitting products such as microwave ovens, whether such interference impairs the operation of the product or vice-versa. Consult the owner's manual for guidance on set-up procedures for minimizing the risks of interference. Any evidence of alteration, erasing or forgery of proof of purchase documents will cause this warranty to be void. This warranty covers only the original owner and is not transferable.*

Any fault, malfunctioning, direct or indirect damage or partial functioning are not covered by warranty. This product is not designed for particular use. Its application field is limited to play music exclusively at home. The continuous functioning, free from faults and malfunctioning is not guaranteed.

- If during the warranty period NORMA receives the notice of a defect, covered by the NORMA warranty, NORMA will fix or replace the product at its discretion. Any replacement product can be a new or semi-new product, provided that it has at least equivalent functionality to the product that will be replaced. The warranty period will be equal to the warranty period remaining on the original product;

- During the warranty period NORMA will at its sole option and expense, repair or replace any product found

to be defective. In the event that the product is no longer available and cannot be repaired effectively, NORMA at its sole option may replace it with a reasonable equivalent, or refund the original purchase price paid. NORMA won't cover the return shipping cost;

- This limited warranty is applicable only in the country where the product was purchased;
- The warranty is valid also only and exclusively for the first subsequent owner, provided that exists a clear and incontrovertible act which proves the change of ownership and that him registers his own product within 30 days from the purchase date. The warranty cannot be extended to the new owner if the previous one did not fulfill the formalities indicated in point 2 of C section;
- The lasting of the warranty period cannot be interrupted for any reason. The non-use of this product does not interrupt or extend the warranty period.

▶ 10.4 Warranty exclusion

- The warranty does not cover the damages due to whichever wrong transport or wrong handling;
- Wires, connectors, selectors, mechanical commands, potentiometers, fuses and other any part subject to wear are not covered by the warranty;
- External connectors, printed circuits and internal components are not guaranteed against, colour alteration and corrosion;
- In any case the external and internal finish are not covered by warranty;
- For the following countries: U.S.A. (United States of America), Canada and Mexico is absolutely prohibite to commercialize, to direct or indirect import and to use for any reason, even temporarily and occasional. OPAL ELECTRONICS and NORMA cannot be held responsible for any unauthorised use of own products.
The only entity authorized to import and sell the products is the official distributor. The official NORMA local dealer becomes subject to liability for the warranty and all legal aspects that it entails, as well as for the sale and use of the product;
- Do not return your product for repair without prior authorization from NORMA. The repair during the limited warranty period by a person not explicitly authorized by NORMA will void the warranty and will be carried out at your risk.

▶ 10.5 Warranty limits

- Any eventual implied warranties, including warranties of merchantability and fitness for a particular purpose shall be limited in duration to the applicable period of time set forth above. NORMA's liability for any defective product is limited to repair or replacement of the product;
- Until the law-concessed point the remedies provided in this warranty are only remedies for the customer;
- It is excluded each refund as well as any contractual or extra contractual liability for direct or indirect damages to persons or things.

▶ 10.6 Responsibility limits

- NORMA does not guarantee that the use of any its product is continuous or free from any error or free from any type of fault;
- Under no circumstances and in no case will NORMA be liable for any accidents, consequential damages, liability, arising from the owner or user due to the failure or inappropriate use of the product;
- In no case and under no circumstances will NORMA be liable for any accident and / or consequential damage to other equipment due to failure or imperfect operation of the NORMA products or the accompanying documentation;
- With the exception of the obligations specifically included in this warranty statement, norma shall not be responsible for incidental or consequential damages or for damages based upon inconvenience, loss of use, damage to any other equipment or other items at the site of use or interruption of performances or any consequences;
- NORMA reserves the right to modify technical characteristics, functional characteristics, prices and anything else it deems useful without any obligation to anyone.

We sincerely thank you for your expression of confidence in NORMA. We wish you many years of listening pleasure.

Table of contents

REVO IPA-80

| | |
|------------------------------|---|
| Safety manual | <ul style="list-style-type: none">I • IntroductionII • UnpackingIII • Before useIV • OperatingV • Recycling & waste |
| User manual | <ul style="list-style-type: none">1 • Controls and connections2 • Start to use3 • Maintenance |
| Aux overview | <ul style="list-style-type: none">4 • Aux overview |
| PH1 phono Optional | <ul style="list-style-type: none">5 • Phono stage |
| USB board Optional | <ul style="list-style-type: none">6 • USB connection |
| Specifications | <ul style="list-style-type: none">7 • Specifications |
| Remote controls | <ul style="list-style-type: none">8 • Aluminium remote RC-43 / 319 • Remote controls description |
| Warranty | <ul style="list-style-type: none">10 • Warranty conditions |



www.normaudio.com - info@normaudio.com - Tel. +39 (0)372 493113

Via Persico, 26 - Loc. Bettenesco - 26043, Persico Dosimo (CR) - Italy